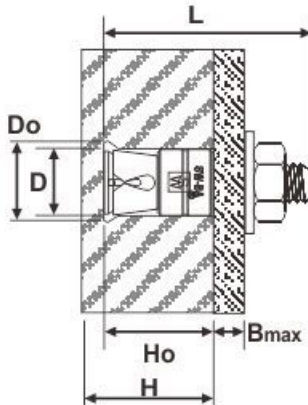
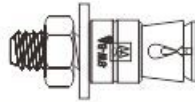

不銹鋼石背螺絲

S.S. Stone Back Anchor

Item	Model	項目	型號	SW-BA M8x40
H (mm)	Manufacturer's recommended stone panel thickness	H (mm)	制造商建議之石材厚度	30
D (mm)	Drill hole diameter	D (Mm)	鑽孔直徑	13
Do (mm)	Hole base diameter	Do (Mm)	基本孔直徑	15.5
Ho (mm)	Manufacturer's recommended drill hole depth	Ho (mm)	制造商建議鑽孔深度	21
Bmax(mm)	Max. Thickness of installation material	Bmax(mm)	最大安裝板材厚度	10
L (mm)	Anchor total length	L (Mm)	螺絲總長度	40

Material 材料 S.S. 304 / S.S. 316

安裝程序

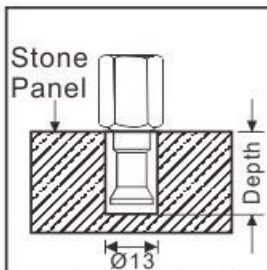
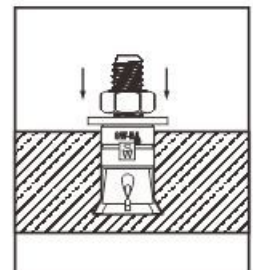
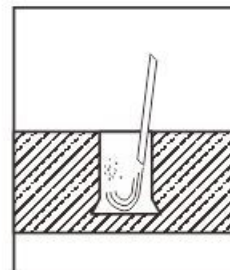
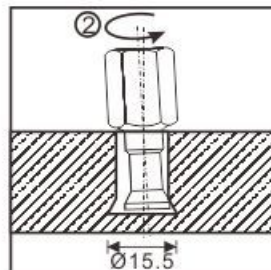
Installation Procedure

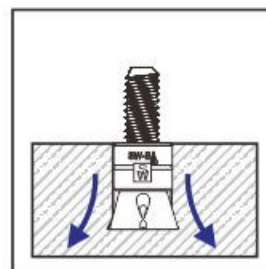
 選擇鑽孔深度
Selected Drill Hole Depth

 M8 士巴拿
M8 Spanner

 一字坑/內六角
Slot type / Hexagon head

Tightening Torque
122 kgf.cm
11.96 N.m

石背螺絲鑽頭(手鑽用)

S.S. Stone Back Anchor Drillhead (For Hand Drill)

石背鑽頭(手鑽用)

補撥孔用

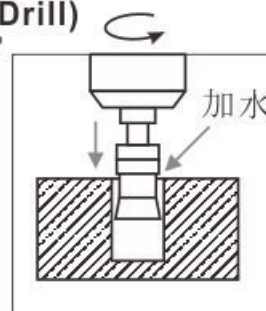
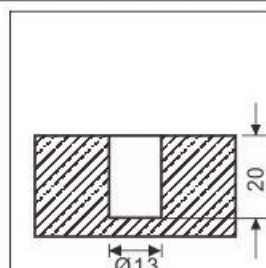

Insert water

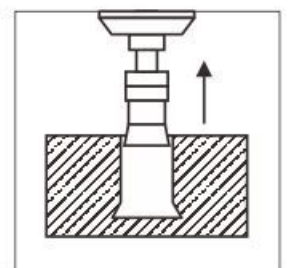

For enlarge the under hole.

如需更多資料或有任何疑問, 請與我們聯絡。

For more information, please contact us.

Tel : (852) 2873 2804 , E-mail : sung@sunwayltd.com.hk

Fax : (852) 2814 0776 , Website : http://www.sunwaymetal.com/

不銹鋼石背螺絲

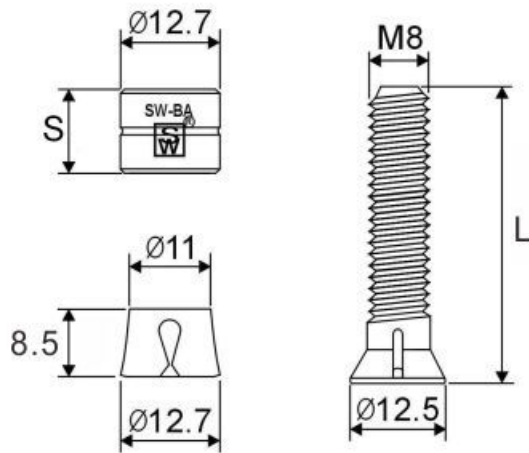
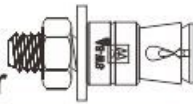
S.S. Stone Back Anchor

		SUNWAY膨脹螺絲外用之不銹鋼介子更強抓著力 2mm厚	一般市面膨脹螺絲外用之不銹鋼介子 1.0 to 1.5mm厚
			
一字坑/內六角設計，方便翻修 Slot type/Hexagon head designed		SUNWAY Stainless Steel Washer of Expansion Bolt can secure the bolt better than the general.	

尺寸選擇

Size Selection

建築板材厚度(mm)	鑽孔深度 (mm)	(S) - 套筒長度(mm)	(L) - 螺絲長度(mm)
Stone Panel Thickness (mm)	Drill Hole Depth (mm)	(S) - Sleeve Length (mm)	(L) - Bolt Length (mm)
25	16	7	40
≥ 30	21	12	40
≥ 40	28	20	55 (需預訂) (Advance Order)

測試簡介

獨立石材配合石背螺絲之測試報告

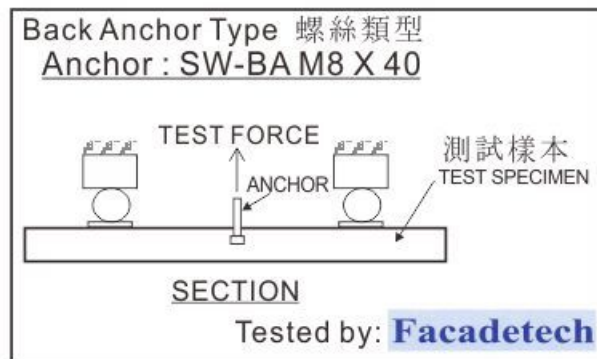
Test Summary
Strength of Individual Stone Anchorages in Dimension Stone

螺絲類型 (每款5件測試樣本)	平均可負載, KN
Stone Type (each types 5 specimens)	Mean Anchorages System Load, KN
Granite St. Nicolas	8.07
Granite White Green	8.67
Granite China Gold	8.01
Granite Black Granite	12.50
Limestone Alexandra Beige	8.86
Limestone Lovely Beige	7.36

石材情況：測試樣本於水缸內存放48小時。

Stone Condition: The tested specimens were soaked in water tank at 22±2 °C for 48 hours.

因石材種類繁多，石背螺絲及鑽頭會因不同石種的硬度及抗壓強度而壽命及負載力有所不同，決定使用石背螺絲前請先行試鑽一定數量之樣本。

Since there are many types of stone in the market, the hardness and the compressive strength of different types of stone may change the useful life of stone back anchor driller and the loading of the anchor.

如需更多資料或有任何疑問，請與我們聯絡。

For more information, please contact us.

Tel : (852) 2873 2804 , E-mail : sung@sunwayltd.com.hk

Fax: (852) 2814 0776 , Website : http://www.sunwaymetal.com/



SW-UDM-1



SW-UDM-5



SW-UDM-4

Stone Back Anchor & Drilling Machine 不銹鋼石背螺絲及鑽床

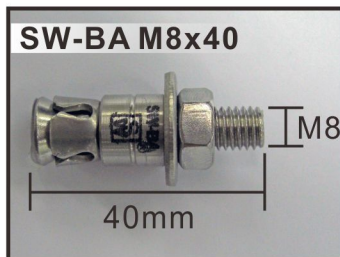

SW-BA M8x40

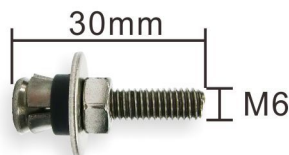
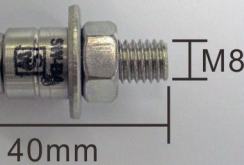

SW-BA M6x30 SW-BAI-M8

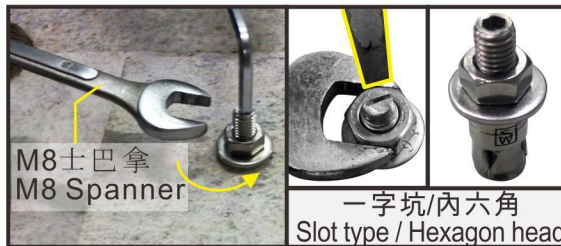
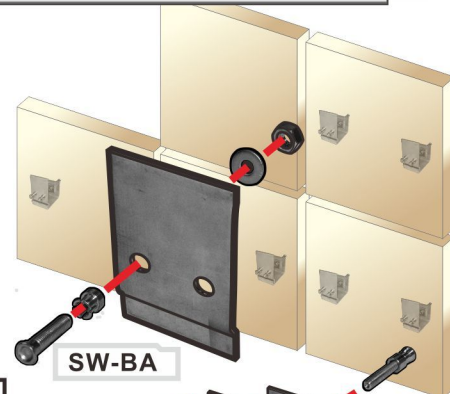

SW-BA Drill

可鑽石材面積：1.5米 x 2米
可鑽石材厚度：28~75mm

- # Stone Back Anchor (M8 x 40) 石背螺絲
- # Stone Back Anchor (M6 x 30) 輕便安裝型石背螺絲
- # Stone Back Anchor Drilling Machine (UDM-5) 石背螺絲鑽床

如需更多資料或有任何疑問，請與我們聯絡。
For more information, please contact us.
Tel : (852) 2873 2804 , E-mail : sung@sunwayltd.com.hk
Fax: (852) 2814 0776 , Website : http://www.sunwaymetal.com/

**全方位石背螺絲鑽床 Model: SW - UDM - 4
CNC Stone Back Anchor Drilling Machine**

只要符合技術參數內之尺寸，
即可於任何一個位置鑽孔，而且呎寸精確，減省人手之誤差

This Machine can drill / operate accurately on any direction.

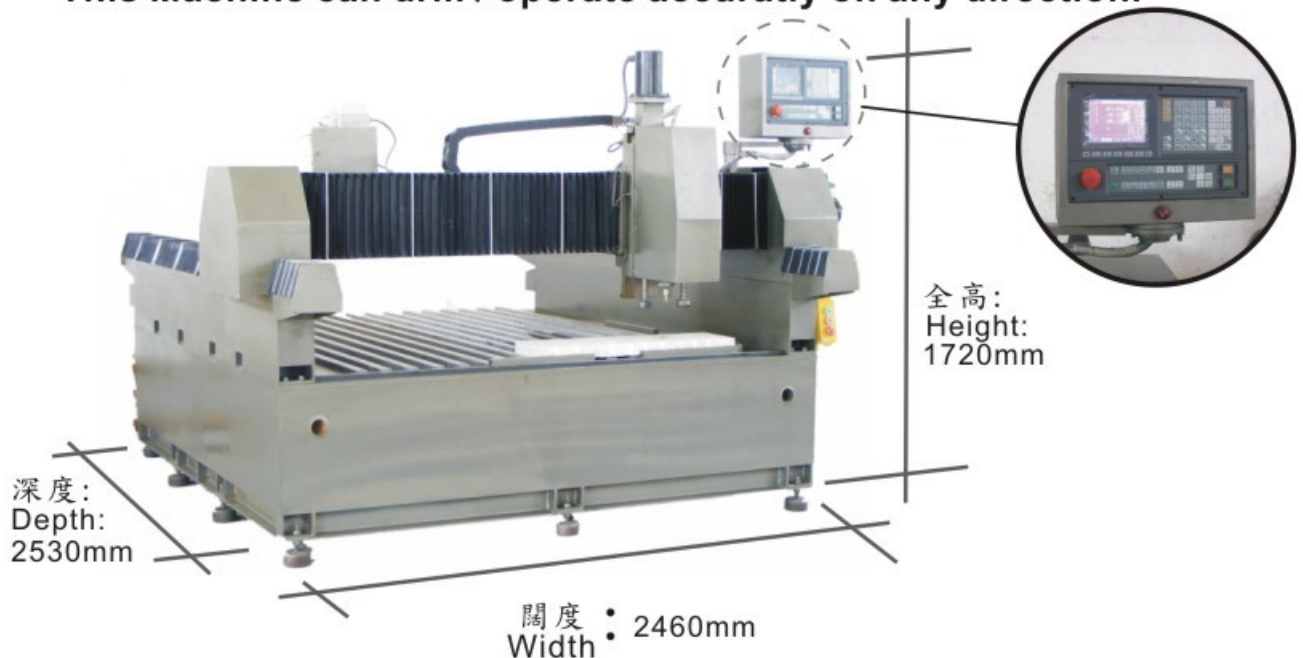

技術參數 Technical reference :	尺寸 Dimension
最大可鑽石 Max. Stone Material Area :	1500 x 1500 mm
最厚可鑽石 Max. Stone Material Thickness :	200 mm

特點
Special Features:

- 全數碼控制，方便快捷及準確
- 可選擇(自動 / 手動)擴孔
開水及關水
- 簡易編制流程，多位置鑽孔
- 操作簡單易明
- Digital Control, Convenience and Accurate
- Automatic or manual operation to enlarge the drill hole and auto control the water system
- Simplified organizing procedures and drilling omnibearing

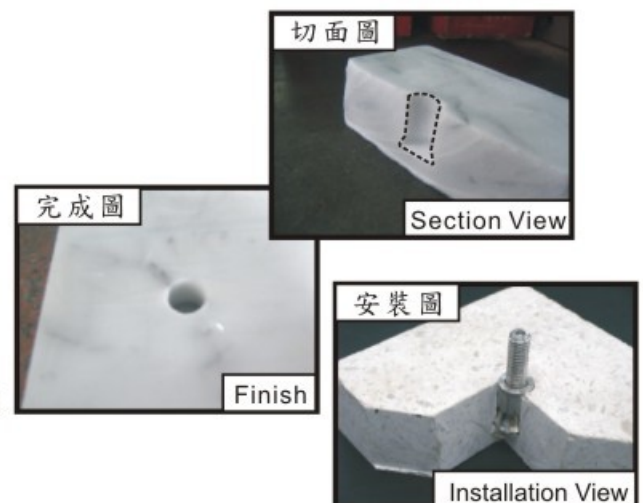

如需更多資料或有任何疑問，請與我們聯絡。

For more information, please contact us.

Tel : (852) 2873 2804 , E-mail : sung@sunwayltd.com.hk

Fax: (852) 2814 0776 , Website : <http://www.sunwaymetal.com/>

虎口式石背螺絲鑽床 (電動及氣動) Model: SW - UDM - 1 Tigers Mouth Type Stone Back Anchor Drilling Machine

此鑽床操作容易，還可根據不同需求來設定鑽孔之深度、大小等。而且配合氣動設計，有效地減低對工件之損害及加快施工程序。
This drilling machine operation is easy operate, may act according to the different demand to the size of the drill hole and so on. Moreover coordinates the air operated design, decreases effectively to harm of the work piece and speeds up the construction schedule.

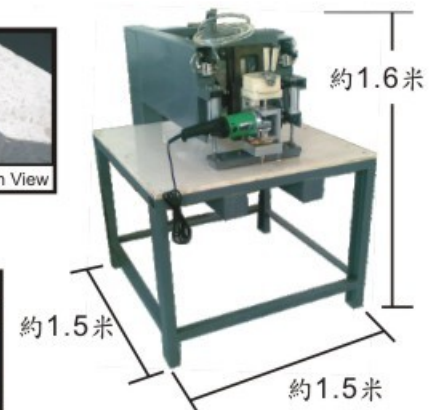
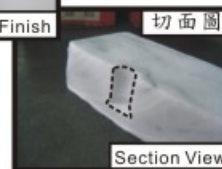
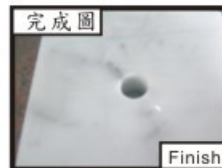
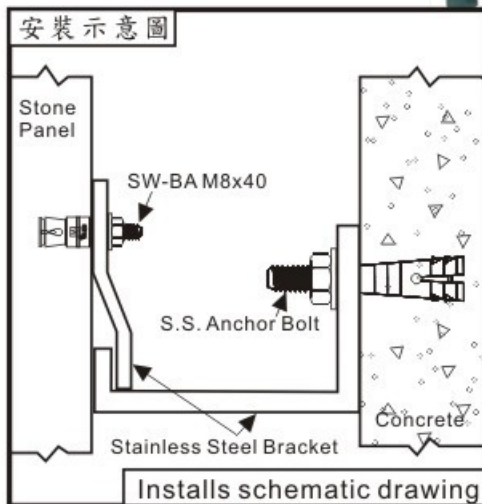
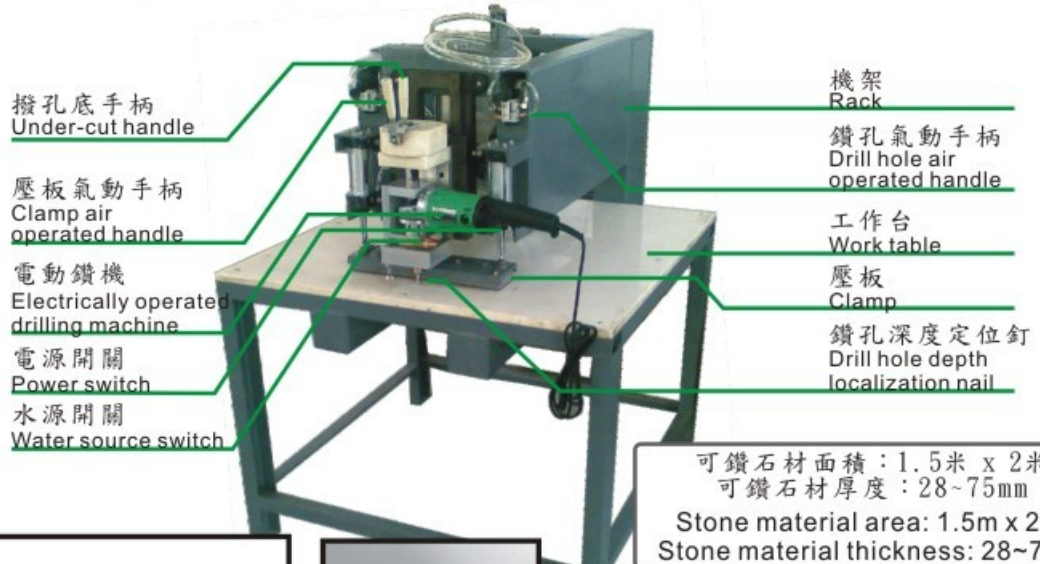

工程項目：	Job Reference:
九龍灣宏泰道 (Mega Box)	NKIL 6268, Wang Tai Road, Kowloon Bay (Mega Box)
澳門美高梅 (MGM) 地盤	Macau (MGM) Project
中峽道	Middle Gap Road Project
道風山 1-2 期	To Fung Shan Project Phase 1 & 2
新浦崗雙喜街 9-11 號	No. 9-11 Sheung Hei Street, San Po Kong
九龍道約道 7 號	No. 7 York Road, Kowloon Tong
1881尖沙咀前水警基地	1881 Heritage Tsim Sha Tsui
科發道2號 - 懿峯	No.2 For Far Road - For Far



道風山 1-2 期
To Fung Shan Project
Phase 1 & 2

如需更多資料或有任何疑問，請與我們聯絡。

For more information, please contact us.

Tel : (852) 2873 2804 , E-mail : sung@sunwayltd.com.hk

Fax: (852) 2814 0776 , Website : <http://www.sunwaymetal.com/>

全方位手提石背螺絲鑽床 **Model: SW - UDM - 5**
Comprehensive Portable Stone Back Anchor Drilling Machine

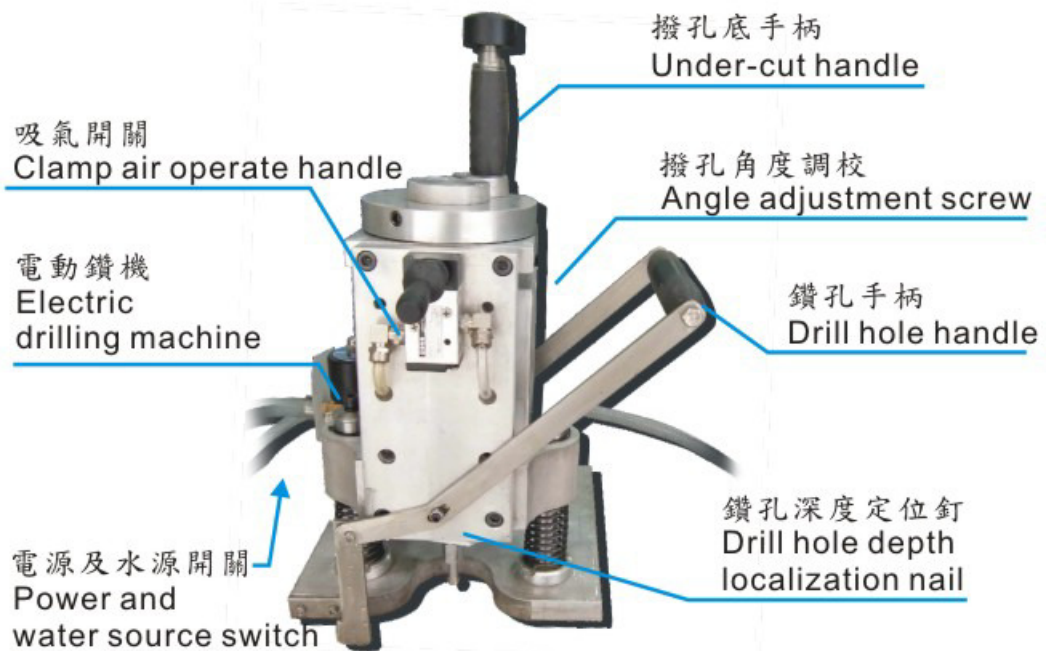

機身重量
16kg



- 全方位鑽孔，無尺寸限制。

No dimension limitation.

此鑽床利用真空吸石原理，固定全方位石材，呎寸無限制地施工，操作容易，手提式設計方便帶出工地，還可根據不同需求來設定鑽孔之深度、大小等。有效地於工地配合需要即時施工。

The drilling machine operation is easy to operate, portable designed also convenience to user and efficiency act according to the different demand to the size of the drill hole

- 有關鑽床操作示範及其它相關資訊，可於本司網頁下載：

The operation movie and the relevant information can be downloaded from the following website:

http://www.sunwaymetal.com/product/sw_udm/index.htm

如需更多資料或有任何疑問，請與我們聯絡。

For more information, please contact us.

Tel : (852) 2873 2804 , E-mail : sung@sunwayltd.com.hk

Fax: (852) 2814 0776 , Website : <http://www.sunwaymetal.com/>



Special made vacuum pump

- 需配合特制真空機，真空吸石固定鑽孔

Vacuum inhalation technology

Model: SW - UDM - 5



使用新和石背螺絲鑽床之注意事項：

Things need to know when using

SUNWAY Stone Back Anchor Drilling Machine SW-UDM-5:



開啟真空吸盤後，要壓下手柄1-2次，
迫出剩餘之空氣以達至最佳之固定效果。

After switching on the vacuum sucker, press down the handle 1-2 times; squeezing out remaining air to achieve the best effect.

真空吸盤開關。
Vacuum sucker switch

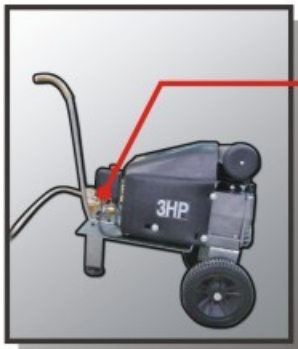

請勿調較此壓力閥。
Do not adjust the pressure valve.

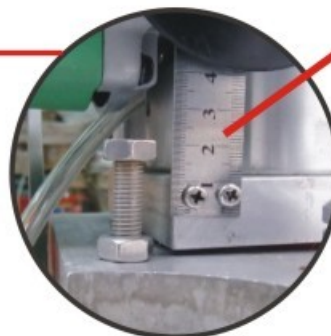

鑽孔深度呎。
Drilling Depth Gauge.

如需更多資料或有任何疑問，請與我們聯絡。

For more information, please contact us.

Tel : (852) 2873 2804 , E-mail : sung@sunwayltd.com.hk

Fax: (852) 2814 0776 , Website : <http://www.sunwaymetal.com/>

不銹鋼石背螺絲

S.S. Stone Back Anchor

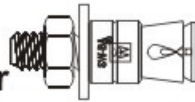

安裝概念圖

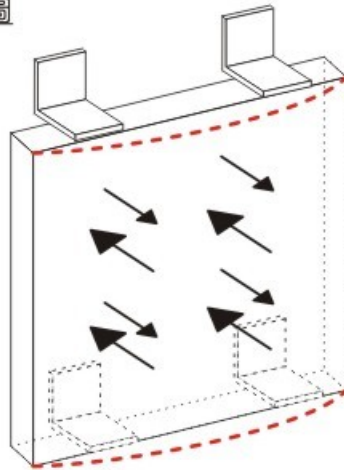

Drawing for reference only

傳統螺絲及碼片安裝於石材邊緣，
石材中央抵抗力可能不足，使中央因長期受壓而隆起。

Traditional anchor bolt & bracket install on the edge of the panel. The centre of panel maybe bulge because of the insufficient resistant and long term pressured.

安裝概念圖

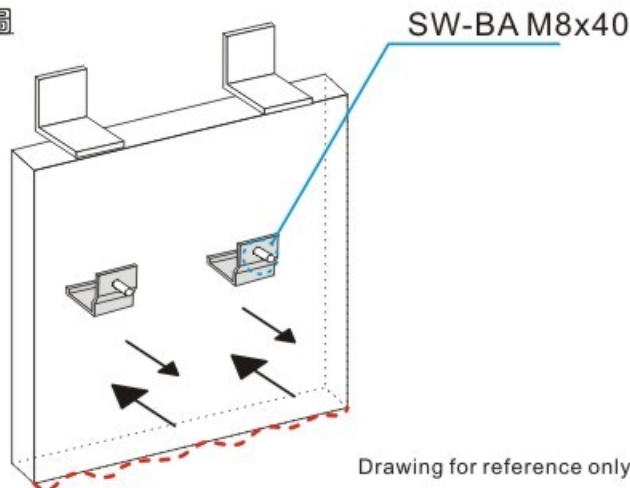

Drawing for reference only

加配石背螺絲安裝於石材底部，能有效抵擋壓力，穩定石材表面。

Install the stone back anchor on the bottom of the panel can efficient withstand the pressure and keep the facade panel stable.

如需更多資料或有任何疑問，請與我們聯絡。

For more information, please contact us.

Tel: (852) 2873 2804 , E-mail: sung@sunwayltd.com.hk

Fax: (852) 2814 0776 , Website: <http://www.sunwaymetal.com/>